

Composite dry sliding bushings, metric dimensions

Principal dimensions			Basic load ratings		Mass	Designation
d	D	B	dynamic C	static C0		
mm			kN		kg	-
16	18	10	12,9	40	0,0039	PCM 161810 E

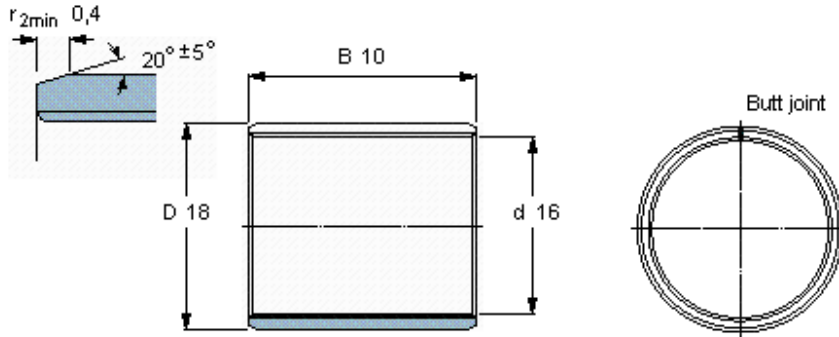

Specific load factor K 80
Material constant K_M 480